

■Features

- High Luminous LEDs
- 5mm Round Standard Directivity
- Superior Weather-resistance
- Flashing Type
- Water Clear Type

■Applications

- Toys
- Games
- Audio
- Other Lighting

■Outline Dimension

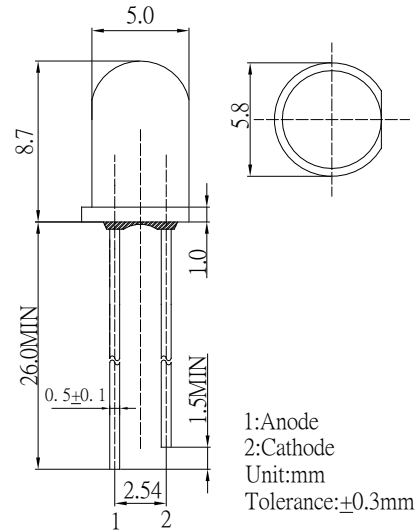

■Absolute Maximum Rating

(Ta=25 °C)

Item	Symbol	Value	Unit
Power Supply	Voltage	5	V
Operating Temperature	Topr	-30 ~ +85	°C
Storage Temperature	Tstg	-40~ +100	°C
Lead Soldering Temperature	Tsol	260°C5sec	-

■Directivity

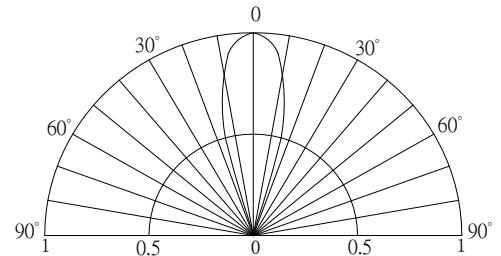

■Electrical -Optical Characteristics

(Ta=25 °C)

Item	Symbo	Condition	Min.	Typ.	Max.	Unit
DC Forward Voltage	V _{dd}	I _F =20mA	3.0	3.3	5.0	V
Oscillator Frequency*	F _{led}	I _F =20mA	-	1.8	-	Hz
Duty Cycle	Duty	I _F =20mA	-	1/2	-	-
Domi. Wavelength*	λ _D	I _F =20mA	520	525	530	nm
Luminous Intensity*	I _v	I _F =20mA	-	1500	-	mcd
50% Power Angle	2θ _{1/2}	I _F =20mA	-	30	-	deg

*1 Tolerance of dominant wavelength is ±1nm

*2 Tolerance of luminous intensity is ±15%

*3 Tolerance of Frequency is ±20%