

### ■Features

- 5ø Standard Directivity
- Superior Weather-resistance
- UV Resistant Epoxy
- Water Clear Type
- RoHS Compliant

### ■Applications

- General Purpose Indicators
- Small Area Illuminations
- Back Lighting

### ■Outline Dimension

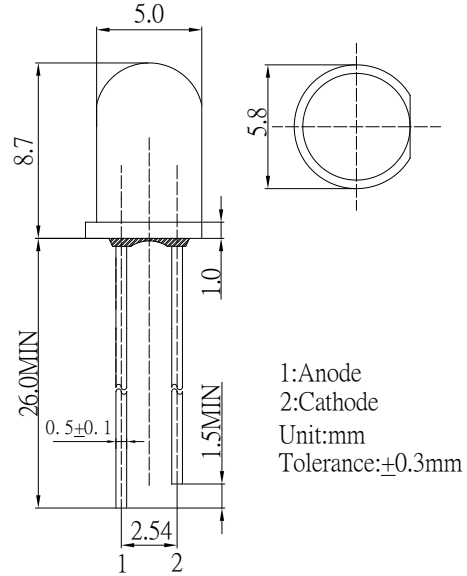

### ■Absolute Maximum Rating

(Ta=25 °C)

Item	Symbol	Value	Unit
DC Forward Current	I <sub>F</sub>	30	mA
Pulse Forward Current*	I <sub>FP</sub>	100	mA
Reverse Voltage	V <sub>R</sub>	5	V
Power Dissipation	P <sub>D</sub>	120	mW
Operating Temperature	T <sub>opr</sub>	-30~ +80	°C
Storage Temperature	T <sub>stg</sub>	-30 ~+100	°C
Lead Soldering Temperature	T <sub>sol</sub>	260°C3sec	-

\*Pulse width Max.10ms Duty ratio max 1/10

### ■Directivity

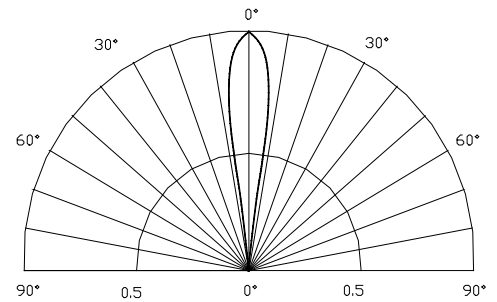

### ■Electrical -Optical Characteristics

(Ta=25 °C)

Item	Symbol	Condition	Min.	Typ.	Max.	Unit
DC Forward Voltage	V <sub>F</sub>	I <sub>F</sub> =20mA	2.8	3.4	4.0	V
DC Reverse Current	I <sub>R</sub>	V <sub>R</sub> =5V		-	10	μA
Luminous Intensity	I <sub>v</sub>	I <sub>F</sub> =20mA	5800	7000	8400	mcd
Chromaticity Coordinate*	x	I <sub>F</sub> =20mA	0.27	0.30	0.33	
	y	I <sub>F</sub> =20mA	0.28	0.31	0.34	
50% Power Angle	2θ <sub>1/2</sub>	I <sub>F</sub> =20mA	-	15	-	deg

\*Please refer to CIE 1931 chromaticity diagram.