

■Features

- High Luminous LEDs
- 5mm Standard Directivity
- Long Lifetime Operation
- Superior Weather-resistance
- UV Resistant Epoxy
- Water Clear Type

■Applications

- Automotive Dashboard Lighting
- Traffic Signal Lamp
- Back Lighting
- Other Lighting

■Outline Dimension

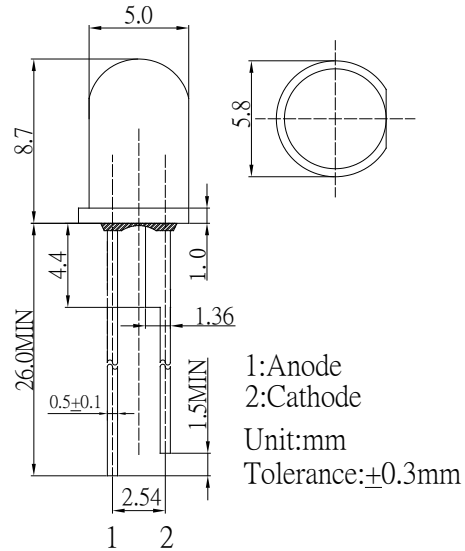

■Absolute Maximum Rating

(Ta=25 °C)

Item	Symbol	Value	Unit
DC Forward Current	I _F	50	mA
Pulse Forward Current*	I _{FP}	120	mA
Reverse Voltage	V _R	5	V
Power Dissipation	P _D	190	mW
Operating Temperature	T _{opr}	-30 ~ +85	°C
Storage Temperature	T _{stg}	-40 ~ +100	°C
Lead Soldering Temperature	T _{sol}	260°C5sec	-

*Pulse width Max.10ms Duty ratio max 1/10

■Directivity

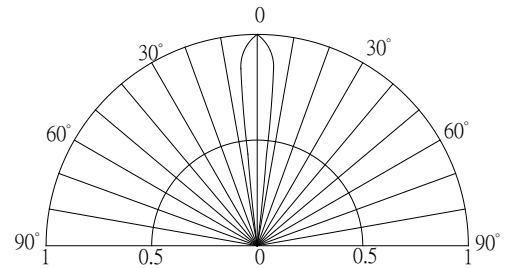

■Electrical -Optical Characteristics

(Ta=25 °C)

Item	Symbol	Condition	Min.	Typ.	Max.	Unit
DC Forward Voltage	V _F	I _F =50mA	3.0	3.3	3.8	V
DC Reverse Current	I _R	V _R =5V	-	-	10	μA
Domi. Wavelength	λ _D	I _F =50mA	465	470	475	nm
Luminous Intensity	I _v	I _F =50mA	25000	30000	-	mcd
50% Power Angle	2θ _{1/2}	I _F =50mA	-	15	-	deg

*1 Tolerance of dominant wavelength is ±1nm

*2 Tolerance of luminous intensity is ±15%