

- * Poles:4-80
 - * Material:NORYL UL 94-V1 ,BLACK
- Specifications**
- * Current rating: 3A AC, DC
 - * Voltage rating: 250V AC, DC
 - * Temperature range: -25°C~+85°C
 - * Insulation resistance: 1,000M Ω min.
 - * Withstand voltage: 800V AC/minute

Polarizing Plug

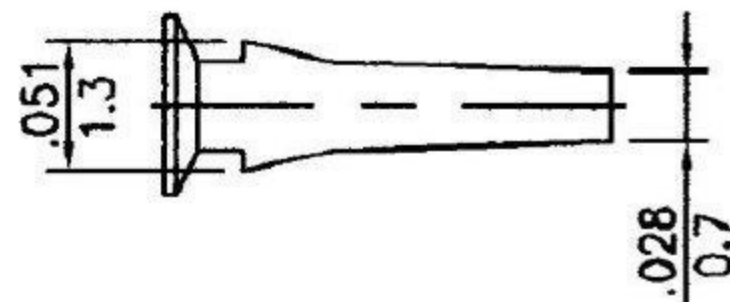

P/N: _____

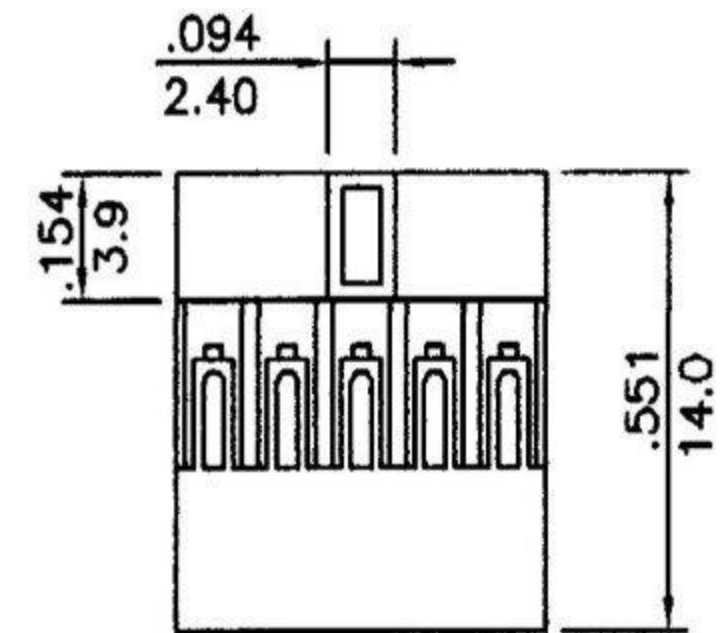
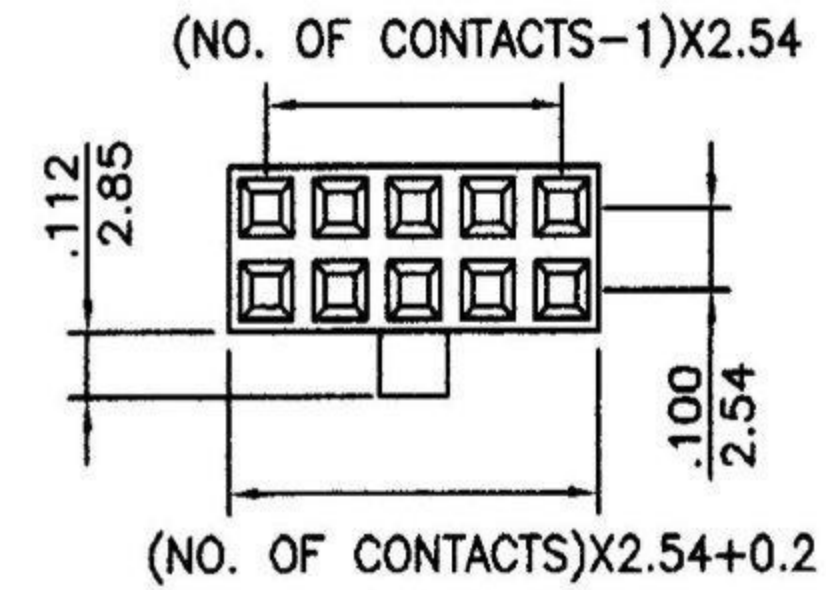
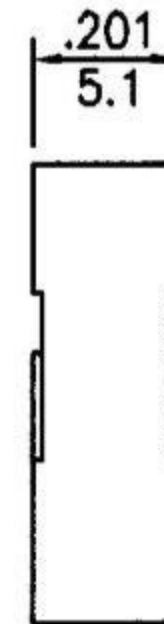
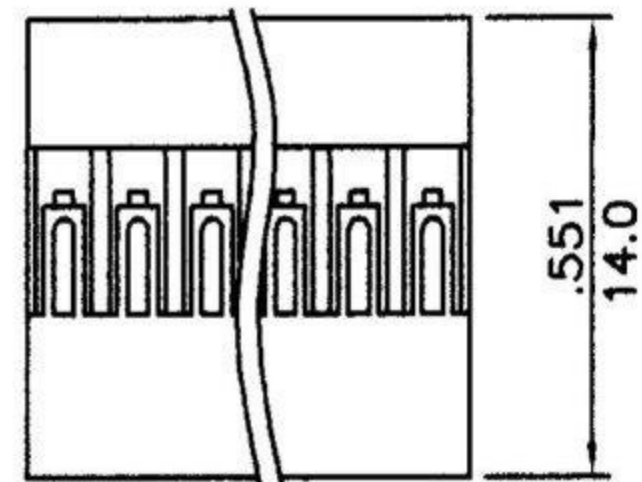
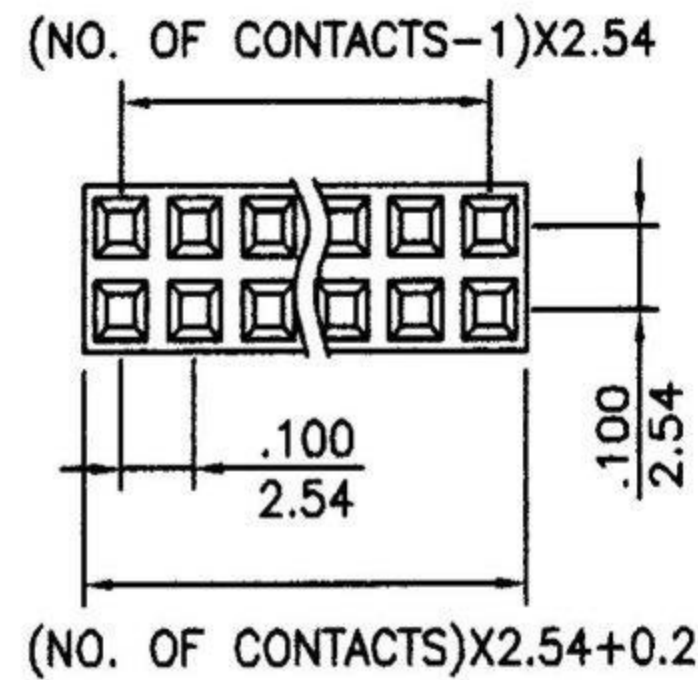

inches
mm

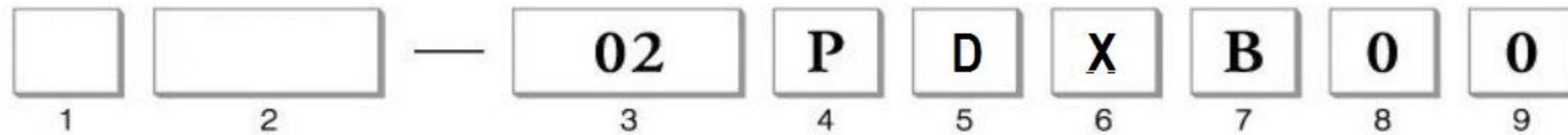

- | | | |
|---|---|--------------------------------|
| 1. PRODUCTS:
H:Housing | 4. CONTACT TYPE:
P:Non Distribution | 7. INSULATOR COLOR:
B:Black |
| 2. SERIES NO.:
4000 | 5. ROW TYPE:
D: Dual Row | 8. FILL IT WITH "0" |
| 3. CONTACT NO.:
04(2x2)-80(2x40)
(Dual Row) | 6. BODY OPTION:
Y:With Bump(Dual Row Only)
N:Without Bump | 9. FILL IT WITH "0" |
- (Wafer:Match with C2100/C2200 Series)

**RoHS
Compliant**

APPD. 核准	SCALE 比例 参考	TOLERANCE 容許公差 .0 ± .00 ± ANG. ±	PART NAME 品名 2.54mm HOUSING DUAL ROW 2X??P BLACK COLOR LOW-LEAD
DWG. 製圖 HELEN	UNIT 單位 MM	SIZE 紙張尺寸 A4	
DATE 制表日 2010/6/23	PAGE 張數 1 OF 1	REV. 版本 A	PART NO. 料號 HEMBRA2X4